

OPTOTRONIC Cable Clamp



Produktfamilien-Eigenschaften

- Einfach zu installierende und flexible Kabelklemmen
- Separate Kabelklemmen für Primär- und Sekundärseite
- Vormontierte, unverlierbare Schrauben
- Durchgangsverdrahtung (TL-Version)

Produktfamilien-Vorteile

- Einfache und schnelle Befestigung der Kabel
- Ausreichend Platz zur Kabelverbindung
- Kostengünstige und platzsparende Lösung (TL-Version)
- Freier Kabelanschluß durch offen stehende Deckel
- Sofortige Installation dank vorkonfektionierten Kabelklemmen

Anwendungsgebiete

- Downlights, flache Leuchten
- Geeignet für unterschiedliche Kabeltypen
- Geeignet für Installationen im Innenbereich

Technische Daten

Produkt-Bezeichnung	Abmessungen & Gewicht				Logistische Daten
	Breite	Länge	Höhe	Produktgewicht	Statistische Warennummer
OT CABLE CLAMP N-STYLE	33,0 mm	37,0 mm	23,0 mm	20,00 g	392690979000
OT CABLE CLAMP A-STYLE	65,0 mm	35,0 mm	25,0 mm	29,00 g	392690979000
OT CABLE CLAMP B-STYLE	57,7 mm	49,2 mm	29,5 mm	26,00 g	392690979000
OT CABLE CLAMP D-STYLE	33,0 mm	38,5 mm	29,5 mm	28,60 g	392690979000
OT CABLE CLAMP E-STYLE	53,0 mm	38,0 mm	25,0 mm	16,00 g	392690979000
OT CABLE CLAMP F-STYLE	53,0 mm	38,0 mm	30,0 mm	16,00 g	392690979000
OT CABLE CLAMP A-STYLE TL	92,0 mm	90,0 mm	25,0 mm	80,00 g	853690100000
OT CABLE CLAMP B-STYLE TL	92,0 mm	90,0 mm	29,5 mm	80,00 g	853690100000
OT CABLE CLAMP B-STYLE LP TL	67,0 mm	50,0 mm	22,0 mm	35,00 g	392690979000
OT CABLE CLAMP D-STYLE TL	57,5 mm	196,6 mm	29,5 mm	60,00 g	853690100000
OT CABLE CLAMP D-STYLE DA TL	57,5 mm	196,6 mm	29,5 mm	70,00 g	853690100000

Produkt-Bezeichnung	Umwelt Informationen Informationen gemäß Art. 33 der EU Richtlinie (EC) 1907/2006 (REACH)			
	Datum der Deklaration	Primäre Erzeugnisnummer	Stoff der Kandidatenliste 1	SCIP Deklarationsnummer
OT CABLE CLAMP N-STYLE	12-02-2022	4062172046732 4052899598461	No declarable substances contained	In Vorbereitung
OT CABLE CLAMP A-STYLE	13-02-2022	4052899089570 4050732499425	No declarable substances contained	Kein deklarationspflichtiger Stoff enthalten
OT CABLE CLAMP B-STYLE	13-02-2022	4052899077881	No declarable substances contained	Kein deklarationspflichtiger Stoff enthalten
OT CABLE CLAMP D-STYLE	30-11-2022	4052899077904 4062172345507	No declarable substances contained	In Vorbereitung
OT CABLE CLAMP E-STYLE	13-02-2022	4052899167896	No declarable substances contained	Kein deklarationspflichtiger Stoff enthalten
OT CABLE CLAMP F-STYLE	12-02-2022	4052899325555	No declarable substances contained	Kein deklarationspflichtiger Stoff enthalten
OT CABLE CLAMP A-STYLE TL	12-02-2022	4052899325982	No declarable substances contained	Kein deklarationspflichtiger Stoff enthalten
OT CABLE CLAMP B-STYLE TL	12-02-2022	4052899948051	No declarable substances contained	Kein deklarationspflichtiger Stoff enthalten
OT CABLE CLAMP B-STYLE LP TL	12-02-2022	4052899530997	No declarable substances contained	Kein deklarationspflichtiger Stoff enthalten
OT CABLE CLAMP D-STYLE TL	30-03-2023	4062172349185	No declarable substances contained	Kein deklarationspflichtiger Stoff enthalten

Familiendatenblatt

Umwelt Informationen
Informationen gemäß Art. 33 der EU Richtlinie (EC) 1907/2006 (REACH)

Produkt-Bezeichnung	Datum der Deklaration	Primäre Erzeugnisnummer	Stoff der Kandidatenliste 1	SCIP Deklarationsnummer
OT CABLE CLAMP D-STYLE DA TL	30-03-2023	4062172349208	No declarable substances contained	Kein deklarationspflichtiger Stoff enthalten

Familiendatenblatt

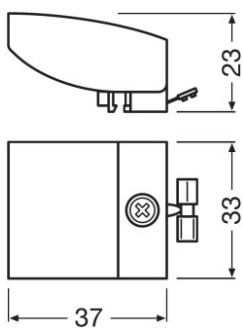

OT Cable clamp N-style

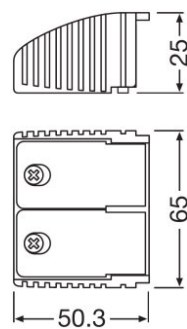

554789_OT CABLE CLAMP A-STYLE

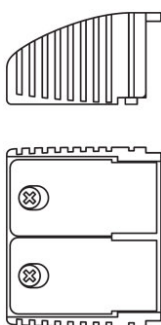

554796_OT CABLE CLAMP A-STYLE

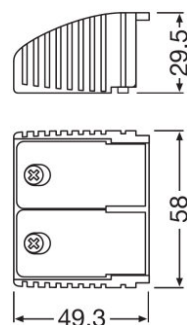

554790_OT CABLE CLAMP B-STYLE

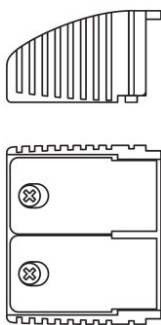

554797_OT CABLE CLAMP B-STYLE

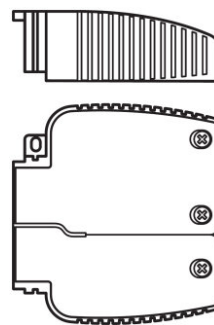

616419_OT CABLE CLAMP B-STYLE

Familiendatenblatt

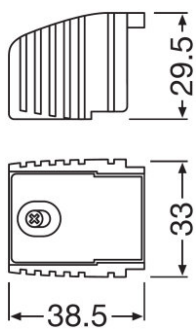

590902_OT CABLE CLAMP D-STYLE

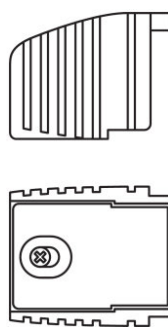

590906_OT CABLE CLAMP D-STYLE

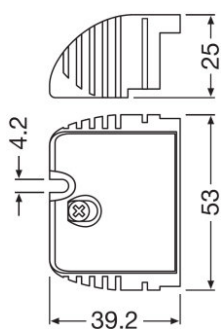

554791_OT CABLE CLAMP E-STYLE

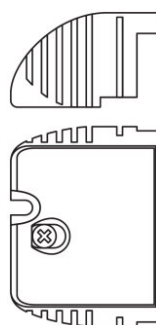

554798_OT CABLE CLAMP E-STYLE

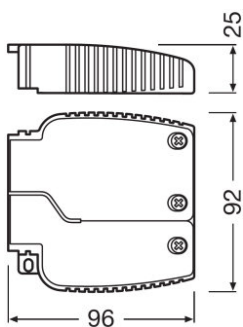

611986_OT CABLE CLAMP A-STYLE TL

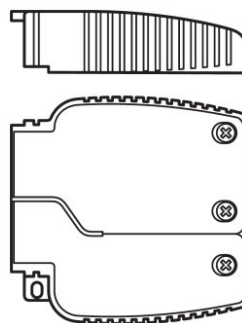

611988_OT CABLE CLAMP A-STYLE TL

Familiendatenblatt

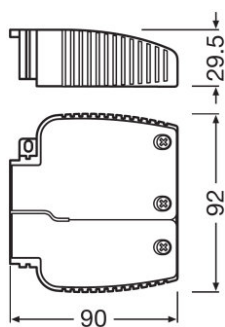

596667_OT Cable Clamp B-Style TL

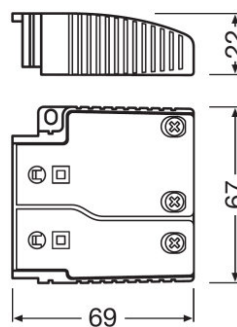

OT CABLE CLAMP B-STYLE LP

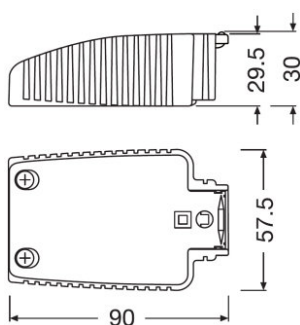

OT CABLE CLAMP D-STYLE

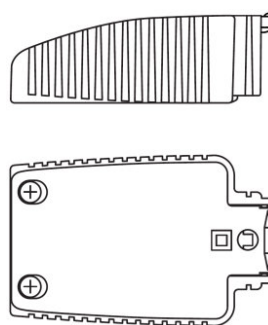

OT CABLE CLAMP D-STYLE



Anwendungshinweis

Für weitere Anwendungsinformationen beachten Sie bitte das Produktdatenblatt.

Verkaufs- und Technischer Support

Verkaufs- und Technischer Support www.osram.de







Downloads

Datei	
	User instruction CABLE CLAMP N-STYLE
	CAD Daten OT Cable Clamp N Style IGS 61119

Familiendatenblatt

	CAD Daten 3-dim OT Cable Clamp N Style STEP 61119
	CAD-Daten PDF OT Cable Clamp N Style CADPDF 61119
	CAD Daten CAD data IGS OT Cable Clamp A-Style
	CAD Daten CAD data STEP OT Cable Clamp A-Style
	CAD-Daten PDF CAD data PDF OT Cable Clamp A-Style
	CAD Daten CAD data IGS OT Cable Clamp B-Style
	CAD Daten CAD data STEP OT Cable Clamp B-Style
	CAD-Daten PDF CAD data PDF OT Cable Clamp B-Style
	CAD Daten CAD Data D-Style-Cable Clamp
	CAD Daten CAD Data D-Style-CableClamp STEP
	CAD-Daten PDF CAD Data D-Style-CableClamp PDF
	CAD Daten CAD data IGS OT Cable Clamp E-Style
	CAD Daten CAD data STEP OT Cable Clamp E-Style
	CAD-Daten PDF CAD data PDF OT Cable Clamp E-Style
	CAD Daten 673587_OT Cable Clamp F Style IGS 61119
	CAD Daten 673588_OT Cable Clamp F Style STEP 61119
	CAD-Daten PDF 673589_OT Cable Clamp F Style CADPDF 61119
	User instruction OT CABLE CLAMP A STYLE TL
	CAD Daten CAD data IGS OT Cable Clamp A-Style TL
	CAD Daten CAD data STEP OT Cable Clamp A-Style TL
	CAD-Daten PDF CAD data PDF OT Cable Clamp A-Style TL
	User instruction OT CABLE CLAMP B STYLE TL
	Anhang TI 592682_Cable Clamp B-Sytle Driver Assembly

Familiendatenblatt

	Installationshinweise 547465_OT Cable Clamp TL-B Instructions sheet
	CAD Daten CAD data IGS OT Cable Clamp B-Style TL
	CAD Daten CAD data STEP OT Cable Clamp B-Style TL
	CAD Daten 3-dim 592683_Cable Clamp B-Sytle STEP
	CAD Daten 3-dim 592684_Cable Clamp B-Sytle IGS
	CAD-Daten PDF CAD data PDF OT Cable Clamp B-Style TL
	User instruction OT CABLE CLAMP B-STYLE LP
	CAD Daten CAD data IGS OT Cable Clamp B-Style LP
	CAD Daten CAD data STEP OT Cable Clamp B-Style LP
	CAD-Daten PDF CAD data PDF OT Cable Clamp B-Style LP
	User instruction OT CABLE CLAMP D-STYLE UI 15118350 230216
	CAD Daten OT Cable Clamp D Style IGS 010323
	CAD Daten OT Cable Clamp D Style STEP 010323
	CAD Daten 3-dim OT CABLE CLAMP D STYLE TL CAD3PDF 210323
	CAD Daten 3-dim OT CABLE CLAMP D STYLE DA TL CAD3PDF 210323

Verpackungsinformationen

Produkt-Code	Produkt-Bezeichnung	Verpackungseinheit (Stück pro Einheit)	Abmessungen (Länge x Breite x Höhe)	Volumen	Gewicht brutto
4062172046732	OT CABLE CLAMP N-STYLE	Versandschachtel 100	380 mm x 297 mm x 208 mm	23.47 dm ³	2571.00 g
4052899089570	OT CABLE CLAMP A-STYLE	Versandschachtel 20	336 mm x 110 mm x 68 mm	2.51 dm ³	672.00 g
4052899077881	OT CABLE CLAMP B-STYLE	Versandschachtel 20	300 mm x 107 mm x 76 mm	2.44 dm ³	605.00 g
4062172345507	OT CABLE CLAMP D-STYLE	Versandschachtel 40	175 mm x 82 mm x 134 mm	1.92 dm ³	1389.00 g

Familiendatenblatt

Verpackungsinformationen

4052899167896	OT CABLE CLAMP E- STYLE	Versandschachtel 20	275 mm x 85 mm x 64 mm	1.50 dm ³	380.00 g
4052899325555	OT CABLE CLAMP F- STYLE	Versandschachtel 20	278 mm x 87 mm x 70 mm	1.69 dm ³	383.00 g
4052899325982	OT CABLE CLAMP A- STYLE TL	Versandschachtel 20	470 mm x 188 mm x 68 mm	6.01 dm ³	1788.00 g
4052899948051	OT CABLE CLAMP B- STYLE TL	Versandschachtel 20	470 mm x 188 mm x 68 mm	6.01 dm ³	1788.00 g
4052899530997	OT CABLE CLAMP B- STYLE LP TL	Versandschachtel 20	256 mm x 146 mm x 82 mm	3.06 dm ³	777.00 g
4062172349185	OT CABLE CLAMP D- STYLE TL	Versandschachtel 20	294 mm x 184 mm x 75 mm	4.06 dm ³	1350.00 g
4062172349208	OT CABLE CLAMP D- STYLE DA TL	Versandschachtel 20	294 mm x 184 mm x 75 mm	4.06 dm ³	1550.00 g

Die genannten Produktnummern beschreiben die kleinste bestellbare Mengeneinheit. Eine Versandeinheit kann mehrere Einzelprodukte beinhalten. Als Bestellmenge verwenden Sie bitte das Ein- oder Mehrfache einer Versandeinheit.

Haftungsausschluss

- Änderungen und Irrtümer vorbehalten. Vergewissern Sie sich, dass Sie immer den neuesten Stand verwenden.