

LINEARlight FLEX Diffuse IP67 Connector

Zubehör für flexible LED-Bänder

Produktfamilien-Eigenschaften

- Quick and easy installation
- Kompatibel mit Linearlight Flex
- Kompatibel mit TEC Flex



Produktfamilien-Vorteile

- Einfache werkzeuglose Montage ohne Löten (CONNECTsystem)
- Verkürzte Montagezeit (CONNECTsystem)
- Anschluss an der Modul-Stirnseite oder an den Trennstellen möglich (CONNECTsystem)
- Flache Bauhöhe (CONNECTsystem)

Technische Daten

Produkt-Bezeichnung	Abmessungen & Gewicht				Logistische Daten
	Produkt-gewicht	Länge	Breite	Höhe	Statistische Warennummer
FX-DCS -G1-CM2PF-IP67-500-X5	105,00 g	26,6 mm	18,5 mm	19,0 mm	853669909900
FX-DCS -G1-CM2PF-IP67-TOPKIT5	122,30 g	260,0 mm	150,0 mm	30,0 mm	853669909900
FX-DCS -G1-CM2PF-IP67-SIDEKIT5	118,10 g	260,0 mm	150,0 mm	30,0 mm	853669909900
FX-DCS -G1-CM2PJ-IP67-0190-X5	85,00 g	26,6 mm	18,5 mm	19,0 mm	853669909900
FX-DCS -G1-CM2PJ-IP67-TOPKIT5	102,30 g	260,0 mm	150,0 mm	30,0 mm	853669909900
FX-DCS -G1-CM2PJ-IP67-SIDEKIT5	98,10 g	260,0 mm	150,0 mm	30,0 mm	853669909900
FX-DCS -G1-ECT-KIT20	34,60 g	9,2 mm	16,1 mm	11,6 mm	392690979000
FX-DCS -G1-ECS-KIT20	26,20 g	6,2 mm	12,0 mm	14,1 mm	392690979000
FX-DCS -G1-EHT-KIT20	63,00 g	17,0 mm	16,1 mm	11,6 mm	392690979000
FX-DCS -G1-EHS-KIT20	51,40 g	11,0 mm	12,4 mm	14,5 mm	392690979000
FX-DCS -G1-GL-25	26,00 g	100,0 mm	150,0 mm	30,0 mm	350610000000

Produkt-Bezeichnung	Umwelt Informationen Informationen gemäß Art. 33 der EU Richtlinie (EC) 1907/2006 (REACH)			
	Datum der Deklaration	Primäre Erzeugnisnummer	Stoff der Kandidatenliste 1	SCIP Deklarationsnummer
FX-DCS -G1-CM2PF-IP67-500-X5	30-08-2022	4052899451971	No declarable substances contained	Kein deklarationspflichtige r Stoff enthalten
FX-DCS -G1-CM2PF-IP67-TOPKIT5	30-08-2022	4052899451995	No declarable substances contained	Kein deklarationspflichtige r Stoff enthalten
FX-DCS -G1-CM2PF-IP67-SIDEKIT5	30-08-2022	4052899452015	No declarable substances contained	Kein deklarationspflichtige r Stoff enthalten
FX-DCS -G1-CM2PJ-IP67-0190-X5	30-08-2022	4052899452039	No declarable substances contained	Kein deklarationspflichtige r Stoff enthalten
FX-DCS -G1-CM2PJ-IP67-TOPKIT5	30-08-2022	4052899452053		In Vorbereitung
FX-DCS -G1-CM2PJ-IP67-SIDEKIT5	30-08-2022	4052899452077	No declarable substances contained	Kein deklarationspflichtige r Stoff enthalten
FX-DCS -G1-ECT-KIT20	30-08-2022	4052899452107	No declarable substances contained	Kein deklarationspflichtige r Stoff enthalten
FX-DCS -G1-ECS-KIT20	30-08-2022	4052899452121	No declarable substances contained	Kein deklarationspflichtige r Stoff enthalten
FX-DCS -G1-EHT-KIT20	30-08-2022	4052899452176		In Vorbereitung
FX-DCS -G1-EHS-KIT20	30-08-2022	4052899452206	No declarable substances contained	Kein deklarationspflichtige r Stoff enthalten
FX-DCS -G1-GL-25	30-08-2022	4052899452244	No declarable substances contained	Kein deklarationspflichtige r Stoff enthalten

Familiendatenblatt

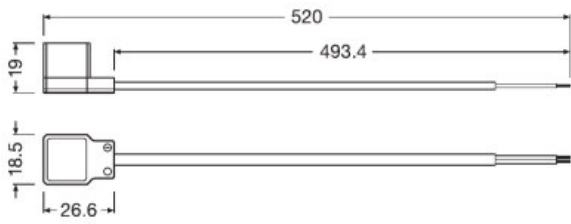

728401_Middle power feeder Flex Diffuse

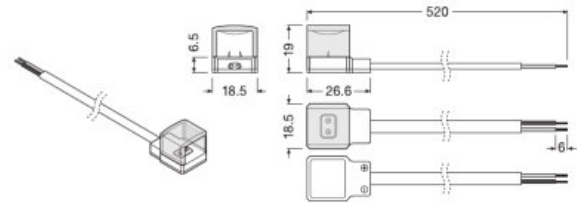

728697_LINEARlight FLEX DIFFUSE FX-DCS-G1-CM2PF-IP67-0500-X5

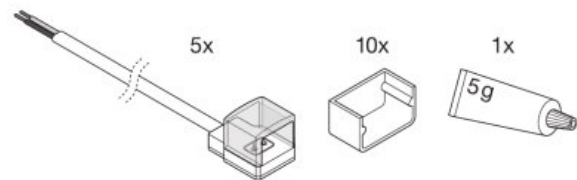

728433_Middle power feeder Flex Diffuse

728701_LINEARlight FLEX DIFFUSE FX-DCS-G1-CM2PF-IP67-TOPKIT5

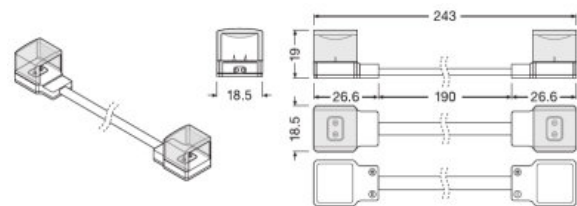
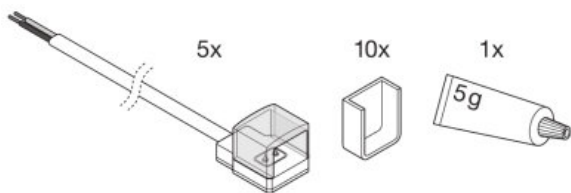

728707_LINEARlight FLEX DIFFUSE FX-DCS-G1-CM2PF-IP67-SIDEKIT5

728698_LINEARlight FLEX DIFFUSE FX-DCS-G1-CM2PJ-IP67-0190-X5

Familiendatenblatt

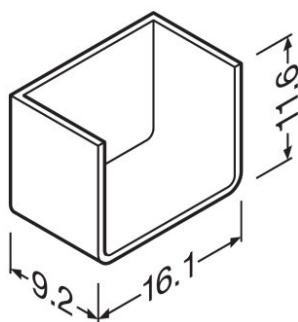

728402_Single sided endcaps for top-bending modules

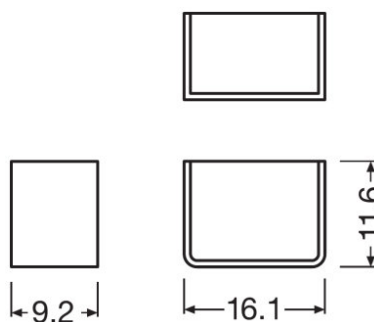

728403_Single sided endcaps for top-bending modules

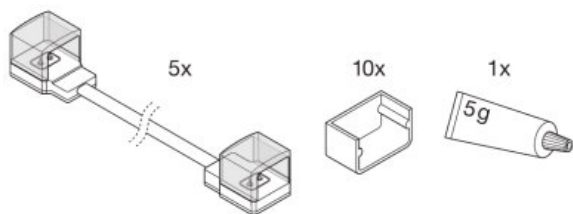

728702_LINEARlight FLEX DIFFUSE FX-DCS-G1-CM2PJ-IP67-TOPKIT5

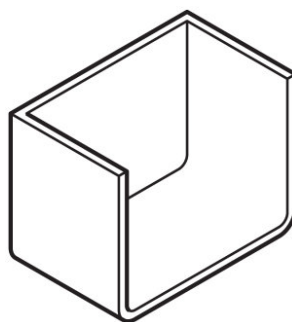

728434_Single sided endcaps for top-bending modules

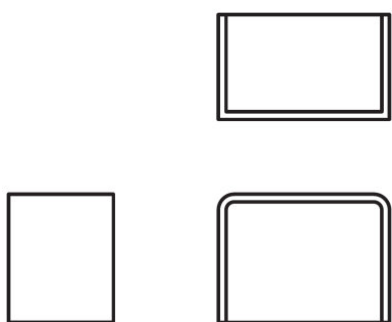

728435_Single sided endcaps for top-bending modules

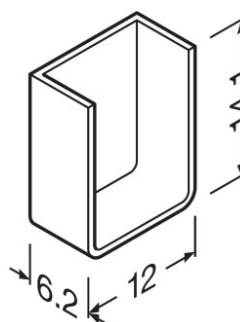

728404_Single sided endcaps for side-bending modules

Familiendatenblatt

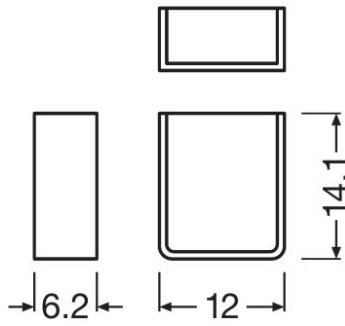

728405_Single sided endcaps for side-bending modules

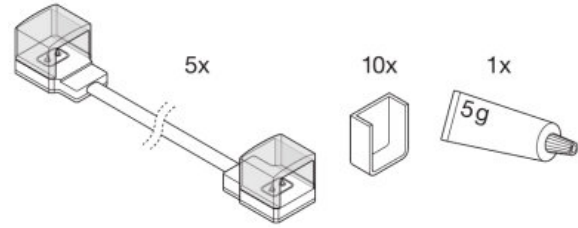

728708_LINEARlight FLEX DIFFUSE FX-DCS-G1-CM2PJ-IP67-SIDEKIT5

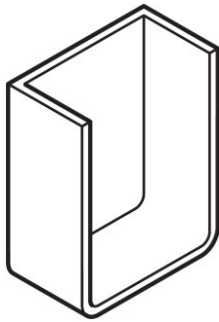

728436_Single sided endcaps for side-bending modules

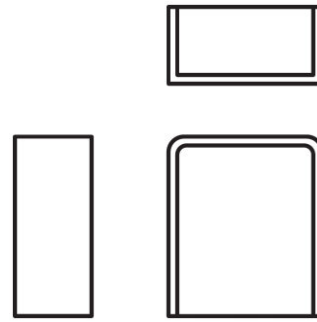

728437_Single sided endcaps for side-bending modules

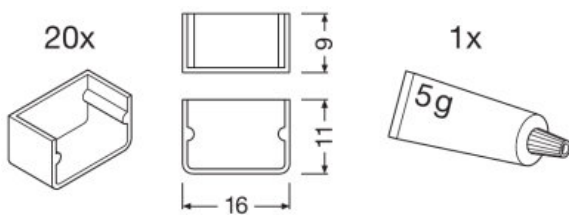

728687_DS063_PG_LINEARlight_FLEX_DIFFUSE_FX-DCS-G1-ECT-KIT20

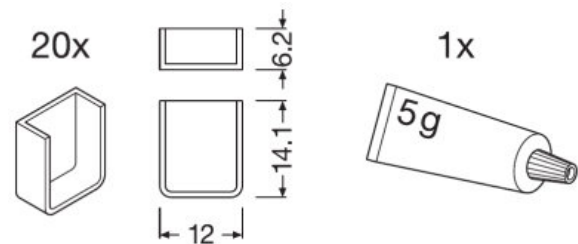

728705_LINEARlight FLEX DIFFUSE FX-DCS-G1-ECS-KIT20

Familiendatenblatt

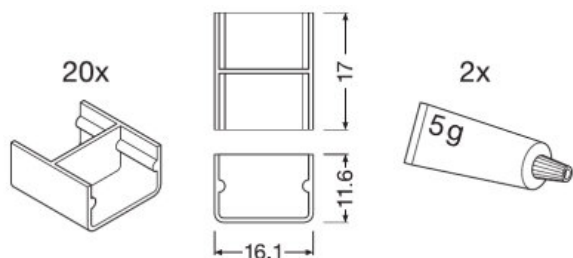

728700_LINEARlight FLEX DIFFUSE FX-DCS-G1-EHT-KIT20

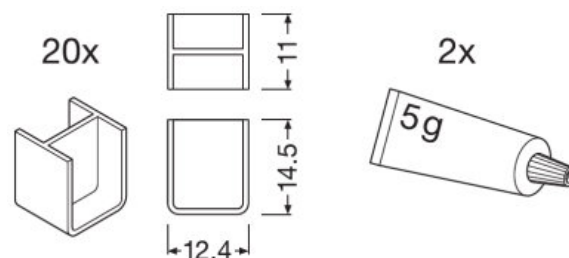

728706_LINEARlight FLEX DIFFUSE FX-DCS-G1-EHS-KIT20

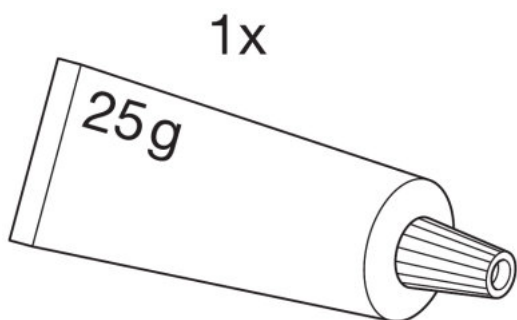

728711_LINEARlight FLEX DIFFUSE FX-DCS-G1-GL-25

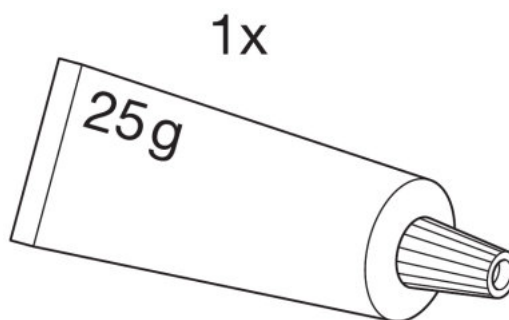

729229_LINEARlight FLEX DIFFUSE FX-DCS-G1-GL-25

Anwendungshinweis

Für weitere Anwendungsinformationen beachten Sie bitte das Produktdatenblatt.

Verkaufs- und Technischer Support

Verkaufs- und Technischer Support www.osram.de

Downloads

Datei	
	User instruction LINEARLIGHT Flex Diffuse Installation Guide - Naed Version (EN)

Familiendatenblatt



Broschüren
Light is freedom of design (EN)

Verpackungsinformationen

Produkt-Code	Produkt-Bezeichnung	Verpackungseinheit (Stück pro Einheit)	Abmessungen (Länge x Breite x Höhe)	Volumen	Gewicht brutto
4052899451971	FX-DCS -G1-CM2PF-IP67-500-X5	Versandschachtel 10	195 mm x 295 mm x 160 mm	9.20 dm ³	1295.00 g
4052899451995	FX-DCS -G1-CM2PF-IP67-TOPKIT5	Versandschachtel 10	195 mm x 295 mm x 160 mm	9.20 dm ³	1468.00 g
4052899452015	FX-DCS -G1-CM2PF-IP67-SIDEKIT5	Versandschachtel 10	195 mm x 295 mm x 160 mm	9.20 dm ³	1426.00 g
4052899452039	FX-DCS -G1-CM2PJ-IP67-0190-X5	Versandschachtel 10	195 mm x 295 mm x 160 mm	9.20 dm ³	1095.00 g
4052899452053	FX-DCS -G1-CM2PJ-IP67-TOPKIT5	Versandschachtel 10	195 mm x 295 mm x 160 mm	9.20 dm ³	1268.00 g
4052899452077	FX-DCS -G1-CM2PJ-IP67-SIDEKIT5	Versandschachtel 10	195 mm x 295 mm x 160 mm	9.20 dm ³	1226.00 g
4052899452107	FX-DCS -G1-ECT-KIT20	Versandschachtel 10	200 mm x 200 mm x 110 mm	4.40 dm ³	496.00 g
4052899452121	FX-DCS -G1-ECS-KIT20	Versandschachtel 10	200 mm x 200 mm x 110 mm	4.40 dm ³	412.00 g
4052899452176	FX-DCS -G1-EHT-KIT20	Versandschachtel 10	200 mm x 200 mm x 110 mm	4.40 dm ³	780.00 g
4052899452206	FX-DCS -G1-EHS-KIT20	Versandschachtel 10	200 mm x 200 mm x 110 mm	4.40 dm ³	664.00 g
4052899452244	FX-DCS -G1-GL-25	Versandschachtel 20	200 mm x 200 mm x 110 mm	4.40 dm ³	760.00 g

Die genannten Produktnummern beschreiben die kleinste bestellbare Mengeneinheit. Eine Versandeinheit kann mehrere Einzelprodukte beinhalten. Als Bestellmenge verwenden Sie bitte das Ein- oder Mehrfache einer Versandeinheit.

Haftungsausschluss

Änderungen und Irrtümer vorbehalten. Vergewissern Sie sich, dass Sie immer den neuesten Stand verwenden.